



# SHOWER BASE

## SB6036L/R-HD

PRODUCT CODE: SB6036L/R-HD

SPECIFICATIONS

### DESCRIPTION

Rectangular acrylic shower base with hidden center drain

### FEATURES

Dimensions: 59 3/4" X 36" x 4" (1516 X 914 X 102 mm)

For corner installation

Acrylic reinforced with 3mm fiberglass with leak protection

The position of the return panel is determined by the selected configuration.



### CERTIFICATIONS

CUPC

CSA B5.2-22/IAPMO Z124-2022

### COLORS (FINISHES)

White

### INSTALLATION TYPE

Right-hand corner: **SB6036L-HD**

Left-hand corner: **SB6036R-HD**

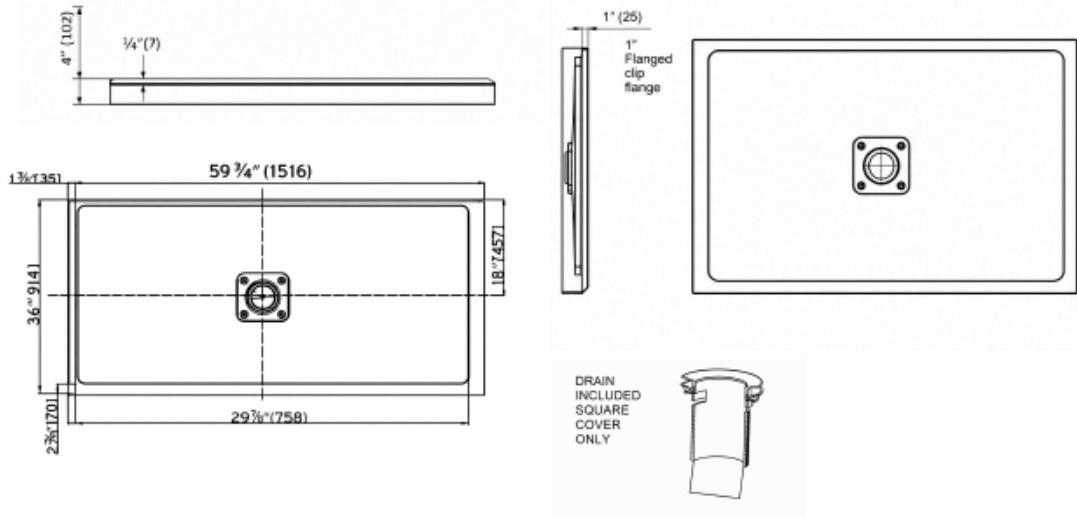

### WARRANTY

All NOVITA shower bases are warranted against manufacturing defects for a period of one (1) year from the date of purchase, under normal use and maintenance conditions. This warranty is valid only if the installation is performed by a licensed master plumber.

