

DESCRIPTION

Rectangular acrylic shower base with hidden center drain

FEATURES

Dimensions: 59 3/4" X 32" x 4" (1516 X 813 X 102 mm)
 For alcove installation
 Acrylic reinforced with 3mm fiberglass with leak protection



CERTIFICATIONS

CUPC
 CSA B5.2-22/IAPMO Z124-2022

COLORS (FINISHES)

White

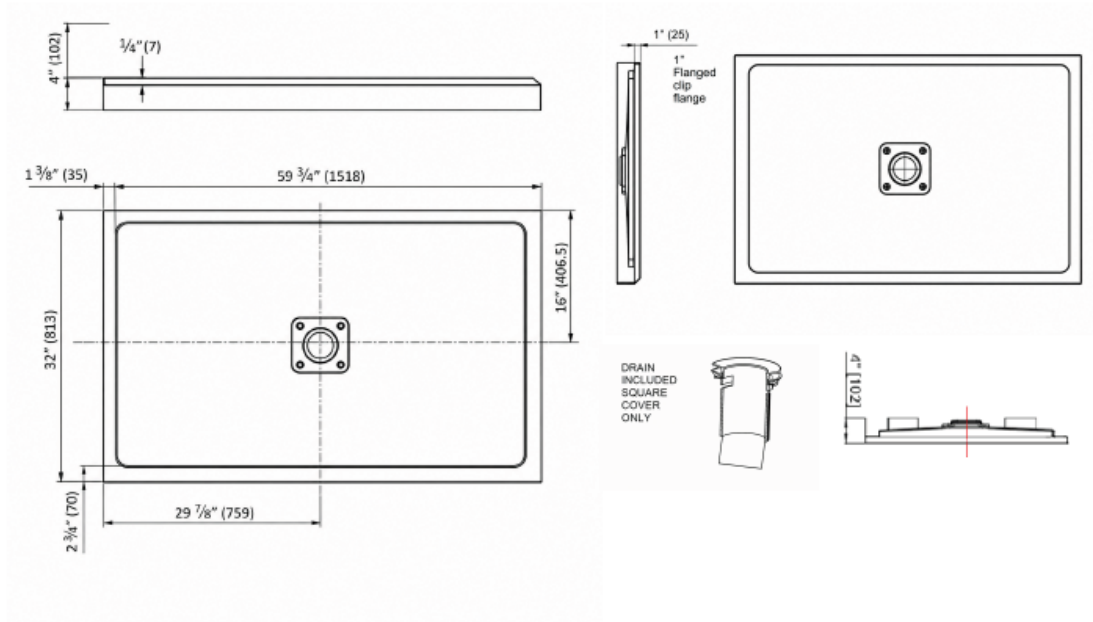

WARRANTY

All NOVITA shower bases are warranted against manufacturing defects for a period of one (1) year from the date of purchase, under normal use and maintenance conditions. This warranty is valid only if the installation is performed by a licensed master plumber.